



REDA

2011 Technical Manual



SRAM LLC WARRANTY

SRAM warrants its products to be free from defects in materials or workmanship for a period of two years after original purchase. This warranty only applies to the original owner and is not transferable. Claims under this warranty must be made through the retailer where the bicycle or the SRAM component was purchased. Original proof of purchase is required.

This warranty statement gives the customer specific legal rights. The customer may also have other rights which vary from state to state (USA), from province to province (Canada), and from country to country elsewhere in the world.

To the extent that this warranty statement is inconsistent with the local law, this warranty shall be deemed modified to be consistent with such law, under such local law, certain disclaimers and limitations of this warranty statement may apply to the customer. For example, some states in the United States of America, as well as some governments outside of the United States (including provinces in Canada) may:

a. Preclude the disclaimers and limitations of this warranty statement from limiting the statutory rights of the consumer (e.g. United Kingdom).

b. Otherwise restrict the ability of a manufacturer to enforce such disclaimers or limitations.

To the extent allowed by local law, except for the obligations specifically set forth in this warranty statement, in no event shall SRAM or its third-party suppliers be liable for direct, indirect, special, incidental, or consequential damages.

· This warranty does not apply to products that have been incorrectly installed and/or adjusted according to the respective SRAM technical installation manual. The SRAM installation manuals can be found online at www.sram.com, www.rockshox.com, www.avidbike.com, www.truvativ.com, or www.zipp.com.

· This warranty does not apply when the product has been modified.

· This warranty does not apply when the serial number or production code has been deliberately altered, defaced or removed.

· This warranty does not apply to damage to the product caused by a crash, impact, abuse of the product, non-compliance with manufacturer's specifications of usage or any other circumstances in which the product has been subjected to forces or loads beyond its design.

· This warranty does not apply to normal wear and tear. Wear and tear parts are subject to damage as a result of normal use, failure to service according to SRAM recommendations and/or riding or installation in conditions or applications other than recommended.

Wear and tear parts are identified as:

Dust seals/Bushings/Air sealing o-rings/Glide rings/Rubber moving parts/Foam rings/Rear shock mounting hardware and main seals/Stripped threads and bolts (aluminum,titanium, magnesium or steel)/Upper tubes (stanchions)/Brake sleeves/Brake pads/Chains/Sprockets/Cassettes/Shifter and brake cables (inner and outer)/Handlebar grips/Shifter grips/Jockey wheels/Disc brake rotors/Wheel braking surfaces/Bottom out pads/Bearings/Bearing Races/Pawls/Transmission gears/Spokes/Free hubs/Aero bar pads/Corrosion/Tools

· This warranty shall not cover damages caused by the use of parts of different manufacturers.

· This warranty shall not cover damages caused by the use of parts that are not compatible, suitable and/or authorized by SRAM for use with SRAM components.

· This warranty shall not cover damages resulting from commercial (rental) use.

ROCKSHOX SUSPENSION SERVICE

We recommend that you have your RockShox suspension serviced by a qualified bicycle mechanic. Servicing RockShox suspension requires knowledge of suspension components as well as the special tools and fluids used for service.

Used suspension fluid should be recycled or disposed of in accordance to local and federal regulations.

NEVER pour suspension fluid down a sewage or drainage system or into the ground or a body of water.

This publication includes trademarks and registered trademarks of SRAM Corporation designated by the symbols ™ and ©, respectively.

Copyright © SRAM LLC 2010

For exploded diagram and part number information, please refer to the Spare Parts Catalog available on our web site at www.sram.com.

For order information, please contact your local SRAM distributor or dealer.

Information contained in this publication is subject to change at any time without prior notice. For the latest technical information, please visit our website at www.sram.com.

Your product's appearance may differ from the pictures/diagrams contained in this catalog.

Product names used in this document may be trademarks or registered trademarks of others.

TABLE OF CONTENTS

SERVICE INTERVALS	5
TOOLS NEEDED FOR SERVICE	6
PARTS NEEDED FOR SERVICE	6
TECHNOLOGY AND OIL VOLUMES	7
TORQUE TIGHTENING VALUES	7
LOWER LEG BUSHING INSPECTION	8
LOWER LEG REMOVAL	9
LOWER LEG SEAL SERVICE	11
DUAL AIR SPRING SERVICE	13
(REBA - REVELATION - SID)	
AIR U-TURN SPRING SERVICE	16
(REBA)	
TURNKEY DAMPER SERVICE	21
(REBA TK - RECON GOLD TK - SEKTOR TK)	
MOTION CONTROL/BLACKBOX MOTION CONTROL DAMPER SERVICE	25
(ARGYLE RCT - REBA RL, RLT ,RLT TI - RECON GOLD RL - REVELATION RL, RLT, RLT TI, WC - SEKTOR RL - SID RL, RLT, RLT TI, WC)	
LOWER LEG INSTALLATION	30
REMOTE SERVICE	32
(PUSHLOC - POPLOC ADJUST - POPLOC)	



SAFETY FIRST!

At SRAM, we care about YOU. Please, always wear your safety glasses and protective gloves when servicing your RockShox suspension. Protect yourself! Wear your safety gear!

SERVICE INTERVALS

The following chart is a summary of the maintenance/service intervals for RockShox forks. Following this schedule is important to ensure the consistent performance and longevity of your fork. Some of the information listed may not be applicable to your fork.

Maintenance	Interval (Hours)
Inspect carbon crown-steerer	Every ride
Clean dirt and debris from upper tubes	Every ride
Check air pressure (air forks only)	Every ride
Inspect upper tubes for scratches	Every ride
Lubricate dust seals and upper tubes	Every ride
Change Speed Lube oil bath	25
Check front suspension fasteners for proper torque	25
Clean and lubricate remote lockout cable and housing	25
Remove lowers, clean/inspect bushings and change oil bath (if applicable)	50
Clean and lubricate air spring assembly	50
Change oil in damping system (including hydraulic lockout)	100
Clean and lubricate coil spring assembly (coil forks only)	100

TOOLS NEEDED FOR SERVICE

The following chart is a list of the model year 2011 tools needed for service on your Reba suspension fork. While this chart is intended to be comprehensive, it is still only a guide. The tools required for each step of service are detailed in the text of the service section.

Tools
Safety/Starting Equipment
Safety Glasses
Nitrile Gloves
Apron
Clean Rags (Lint Free)
Oil Measuring Device
Oil Pan
Clean Work Area
General Tools
Hex Key Set (Sizes 1.5 mm - 5 mm)
Plastic Mallet
Socket Wrench
24 mm Socket
10 mm Socket
Torque Wrench
Schrader Valve Tool
Snap Ring Pliers (External)
Snap Ring Pliers (Internal)
Long Dowel Rod
Sharp Pick
Magnet
Oil/Liquids
Suspension Oil (RockShox 5wt)
Grease (Suspension Oil Soluble)
Isopropyl Alcohol

PARTS NEEDED FOR SERVICE

Prior to servicing your fork, it is important that you have all of the necessary replacement parts. For exploded diagram and part number information, please refer to the Spare Parts Catalog available on our web site at www.sram.com. For order information, please contact your local SRAM distributor or dealer.

TECHNOLOGY AND OIL VOLUMES

The following chart is a complete list of the 2011 RockShox Reba line-up. It details the model, corresponding damper and spring technology, along with the oil volume and RockShox oil weight required for each upper tube and lower leg.

Reba	TK	Turnkey	Volume (ml)	Oil wt	Volume (ml)	Oil wt	Spring Technology (Non-Drive Side)	Volume (ml)	Oil wt	Volume (ml)	Oil wt
			Upper Tube		Lower Leg			Upper Tube		Lower Leg	
			133								
	XX, RL, RLT	Motion Control	123	5	5	15	Dual Air				
	RLT Ti	Blackbox Motion Control	133				Air U-Turn	Grease	Grease	5	15
						Dual Air					
						Air U-Turn					
							Dual Air				

TORQUE TIGHTENING VALUES

The following chart is a summary of the primary torque tightening values for Reba forks. The torque tightening values for fasteners that require a specific torque are detailed in the text of each service section.

Fastener	Torque Value
Top Cap	7.3 N·m (65 in-lb)
Top Cap (Air U-Turn Only)	14.6 N·m (130 in-lb)
Bottom Bolt/Shaft Nut	6.8 N·m (60 in-lb)
Brake Caliper Mounting Bolts (Post Mount)	10.2 N·m (90 in-lb)

LOWER LEG BUSHING INSPECTION

INTRODUCTION

Suspension fork bushings are considered "wear and tear" parts. The rate and amount of wear will depend on the frequency of fork service, frequency of riding, riding terrain, rider body weight, and type of fork. If your bushings are worn, you will need to replace your lower leg assembly. The following chapter covers how to check for bushing wear.

CHECK FOR BUSHING WEAR

Method 1: Check for bushing wear while the fork is installed on the bike

1. Compress the fork 5 times to circulate lower leg lubrication.
2. Wrap your fingers around the lower leg just below the the dust seal. Hold the front brake lever tight while rocking the bike back and forth (you may need someone to do this for you while you hold the lower leg). If you hear or feel any "knocking" at the lower leg, the bushings are worn.



OR

Method 2: Check for bushing wear while the fork is removed from the bike

1. Compress the fork 5 times to circulate lower leg lubrication.
2. Brace the fork on a table or the floor to hold it steady. Hold the fork crown tight in one hand and the brake arch in the other hand. Try to move the brake arch back and forth. If you hear or feel any "knocking", the bushings are worn.

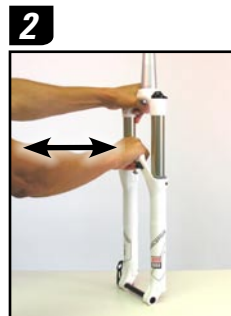

If you have determined that the bushings are worn, you will need to replace the lower leg assembly. Reference the 2011 RockShox Spare Parts Catalog for information on the correct lower leg and corresponding part number for your fork.

LOWER LEG REMOVAL

INTRODUCTION

Removing the lower legs is the first step in servicing your fork. Once you have removed your fork lower legs, you'll be ready to move onto the next section.

LOWER LEG REMOVAL

1. **Coil forks:** Proceed to Step 4.
2. **Air forks:** Remove the positive air chamber valve cap from the top cap located on the non-drive side fork leg. If the fork also has a negative air chamber, remove the valve cap located at the bottom of the non-drive side air chamber.
The positive air chamber valve cap for 2-Step and Dual Position Air forks is located at the bottom of the non-drive side fork leg.

2



3



3. Depress the Schrader valve and release all of the air pressure from the air chamber.
If the fork has a negative air chamber, start with the negative air chamber first, then proceed to the positive air chamber.

⚠ CAUTION

Verify all pressure is removed from the fork before proceeding. Failure to do so can result in injury and/or damage to the fork.

4. Remove the external rebound adjuster knob (if applicable) by pulling it from the shaft bolt at the bottom of the right fork leg.
5. Use a 5 mm hex wrench to loosen both shaft bolts 3 to 4 turns.
Dual Air, Air U-Turn, 2-Step, and Dual Position Air equipped forks: Use a 10 mm socket (or open end) wrench to loosen and unthread the shaft nut at the bottom of the left fork leg until it is flush with the threaded shaft end.

4



5



6



5. Use a 5 mm hex wrench to loosen both shaft bolts 3 to 4 turns.
Dual Air, Air U-Turn, 2-Step, and Dual Position Air equipped forks: Use a 10 mm socket (or open end) wrench to loosen and unthread the shaft nut at the bottom of the left fork leg until it is flush with the threaded shaft end.
For hollow bottom fork legs you will need to use a deep 10 mm socket to loosen and unthread the air shaft nut.
6. Place an oil pan beneath the fork to catch any draining oil. Use a plastic mallet to firmly strike each shaft bolt/nut free from its press-fit to the lower leg and use your fingers to remove the shaft bolts/nut completely.
For hollow bottom fork legs tap the 5 mm hex wrench and 10 mm deep socket while engaged in the bolts to free them from the press-fit.

LOWER LEG REMOVAL (CONTINUED)

7. Firmly pull the lower leg downward until oil begins to drain.
If the upper tubes do not slide out of the lower leg or if oil doesn't drain from either side, the press fit of the shaft(s) to the lower leg may still be engaged. Re-install the shaft bolt(s) 2 to 3 turns (or re-install the shaft nut flush with the threaded shaft end) and repeat Step 6. Do not hit the brake arch with any tool when removing the lower leg as this could damage the fork.
8. Remove the lower leg from the fork by pulling it downward, holding onto both legs or the brake arch.
9. Spray isopropyl alcohol on and into the lower leg assembly. Wipe the lower legs clean, then wrap a clean rag around a dowel and clean the inside of each lower leg.

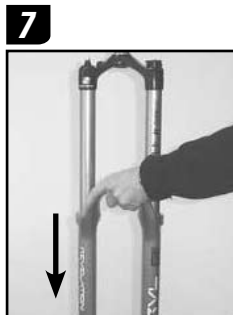

LOWER LEG SEAL SERVICE

INTRODUCTION

Suspension fork seals are considered "wear and tear" parts and require regular maintenance, depending on the frequency of riding, riding terrain, and type of fork. The more you ride, the more frequently your seals need to be replaced. The following chapter covers wiper and oil seal removal and installation. At this point you should already have the lower legs removed from your fork. If not, you will need to return to the Lower Leg Removal section of this manual and follow the instructions for removing your fork lower legs.

LOWER LEG SEAL REMOVAL

1. Select one side of the lower leg to work on first.
Oil seal: If your fork has a black oil seal between the dust wiper and the upper bushing, position the tip of a downhill tire lever or large, flat head screwdriver between the lower lip of the black oil seal and the upper bushing.
No oil seal: If your fork does not have a black oil seal between the dust wiper and the upper bushing, place the tip of the tool underneath the lower lip of the wiper seal.
If you use a flat head screwdriver, make sure it has a round shaft. A screwdriver with a square shaft will damage the fork leg.
2. Stabilize the lower leg upright on a bench top or on the floor. Hold the lower leg firmly and use downward force on the tool handle to leverage the seal(s) out.
Keep the lower leg assembly stable. Do not allow the lower legs to twist in opposite directions, compress toward each other or be pulled apart. This will damage the lower leg assembly.
3. If your fork has an oil foam ring, remove it with your fingers.
4. Repeat steps 1 - 3 for the other side of the lower leg.
5. Spray isopropyl alcohol on and into the lower leg. Wipe the lower legs clean, then wrap a clean, lint free rag around a dowel and clean the inside of each lower leg.

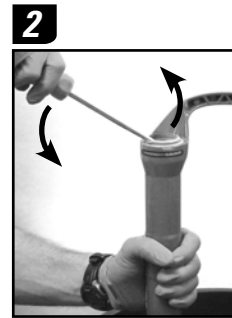
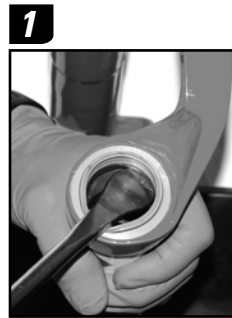

LOWER LEG SEAL INSTALLATION

Foam ring installation

1. If your fork has foam rings, soak the new foam rings in 15wt RockShox suspension oil.
2. Insert a new oil-saturated foam ring into each side of the lower leg.

1



2



Oil seal installation

1. Position the oil seal, with the grooved side visible, onto the stepped side of the seal installation tool.
2. Hold one of the lower legs firmly and use the seal installation tool to push the oil seal evenly and completely into that leg. Repeat for the other leg.

Be sure to stabilize the lower leg in order to prevent it from slipping while installing the seal.

1



2



Dust wiper installation

1. Position the dust wiper into the recessed side of the seal installation tool, so that the grooved side of the seal is visible.
2. Hold one of the lower legs firmly and use the seal installation tool to push the dust wiper evenly and completely into that leg. There should be no visible gap between the dust wiper and the lower leg. Repeat for the other leg.

Be sure to stabilize the lower leg in order to prevent it from slipping while installing the seal.

1

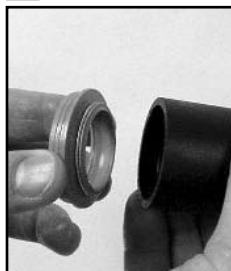

2



DUAL AIR SPRING SERVICE

(REBA - REVELATION - SID)

INTRODUCTION

At this point you should already have the lower legs removed from your fork. If not, you will need to return to the Lower Leg Removal section of this manual and follow the instructions for removing your fork lower legs.

DUAL AIR SPRING REMOVAL/SERVICE INSTRUCTIONS

CAUTION

Verify all pressure is removed from the fork before proceeding. Depress the positive and negative Schrader valves again to remove any remaining air pressure. Failure to do so can result in injury and/or damage to the fork.

1. Use a 24 mm socket wrench to unthread and remove the air spring top cap.
2. Push the negative air shaft into the base plate, leaving just enough shaft exposed to hold onto with your fingers.

You may need to depress the Schrader valve as you push the shaft, to prevent a vacuum.

3. Slide a 15 mm socket tool (or similar hollow tool) over the air shaft end and press firmly against the base plate. While pressing the air base plate into the upper tube, remove the snap ring using large external snap ring pliers.
4. Firmly pull the air shaft down to remove the air spring assembly from the upper tube.
5. Spray isopropyl alcohol on the inside and outside of the upper tube and wipe with a clean rag. Wrap a clean rag around a long dowel and insert it into the upper tube to clean inside the upper tube.
6. **SID only:** Remove the base plate/wavy washer/aluminum support washer/negative piston assembly from the air shaft.
SID 120, Reba, and Revelation only: Remove the base plate, wavy washer, aluminum support washer, negative piston top out bumper, and negative air piston from the air shaft.

1



2

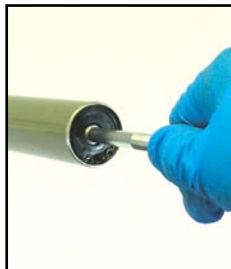

3



4



6

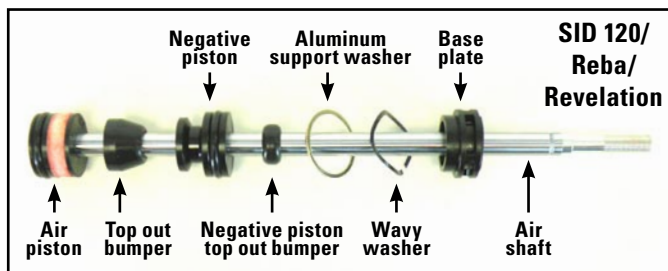
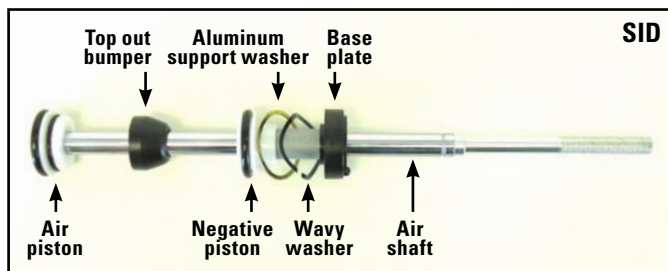
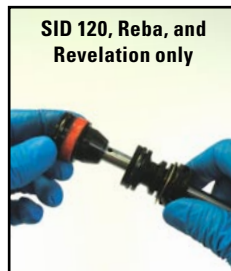
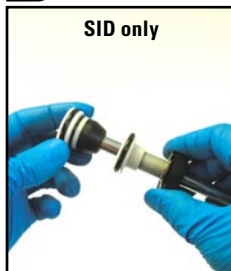

DUAL AIR SPRING REMOVAL/SERVICE INSTRUCTIONS (CONTINUED)

7. Use a pick to remove the inner and outer negative piston o-rings. Apply grease to the new o-rings and install them.

When using a pick to remove o-rings, do not scratch the negative piston. Scratches may cause air to leak.

8. Use a pick to remove the air piston o-ring. Apply grease to the new o-ring and install it.

SID and SID 120 only: Use a pick to remove the secondary air piston o-ring. Apply grease to the new o-ring and install it.

Reba and Revelation only: Use a pick to remove the foam ring from the air piston. Install the new foam ring onto the piston, then saturate it with RockShox suspension oil.

When using a pick to remove o-rings, do not scratch the negative piston. Scratches may cause air to leak.

7



8

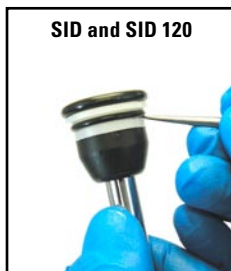

SID and SID 120



Reba and Revelation



Reba and Revelation

OPTIONAL - ALL TRAVEL CONFIGURATIONS

All Travel spacers are located just above the top out bumper washer (SID) or between the base plate and negative piston (SID120/Reba/Revelation). If you want to change the travel of your fork, install the travel spacer(s) onto the Dual Air shaft to decrease travel, or remove them to increase travel.

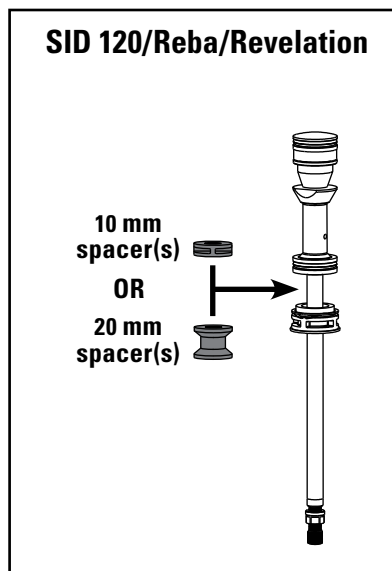
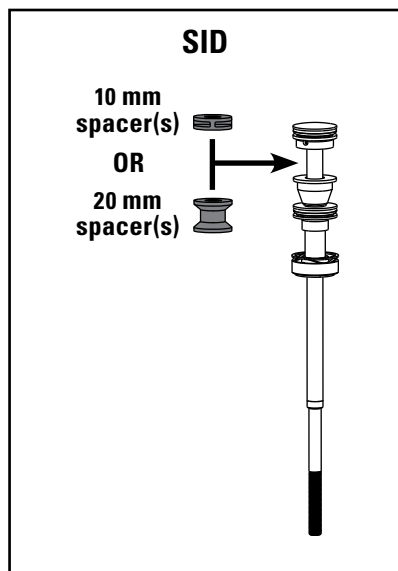

DUAL AIR SPRING INSTALLATION INSTRUCTIONS

9. Apply grease to the negative piston inner o-ring.
10. **SID only:** Re-install the base plate/wavy washer/aluminum support washer/negative piston assembly onto the air shaft.

9



10

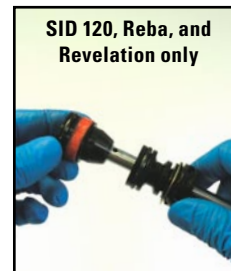
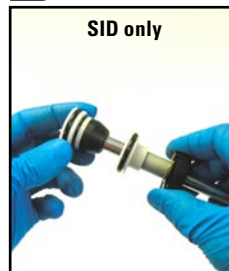

- SID 120, Reba, and Revelation only:** Re-install the negative piston, base plate bumper, aluminum support washer, wavy washer, and base plate onto the air shaft.
11. Apply a liberal, even layer of grease, along the inside of the upper tube. Spread the grease so it extends approximately 40 mm from the bottom of the upper tube.

11

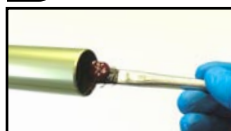

12

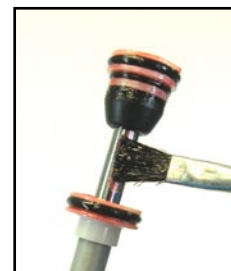

12. Apply a liberal amount of grease to the air piston o-rings and the air shaft.
13. Insert the Dual Air assembly into the upper tube, air piston first, followed by the negative piston and base plate assembly.
14. Push the negative air shaft into the base plate, leaving just enough shaft exposed to hold onto with your fingers.

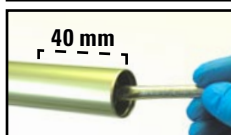

You may need to depress the Schrader valve as you push the shaft, to prevent a vacuum.

15. Use your thumb to press the base plate into the upper tube until the snap ring groove is visible. Use large snap ring pliers to secure the snap ring in its groove. Position the snap ring eyelets on either side of the base plate tab.

13



14

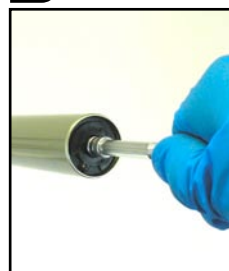

- Make sure the snap ring is securely fastened in the snap ring groove. You can check this by using the snap ring pliers to rotate the snap ring back and forth a couple of times, then firmly pulling down on the air shaft.**

Snap rings have a sharper-edged side and a rounder-edged side. Installing snap rings with the sharper-edged side facing the tool will allow for easier installation and removal.

16. Use isopropyl alcohol and a clean rag to clean the top cap, then apply a small amount of grease to the top cap o-ring. Insert the top cap into the upper tube/crown and hand thread it into the upper tube. Be careful not to damage the top cap o-ring upon installation.

15

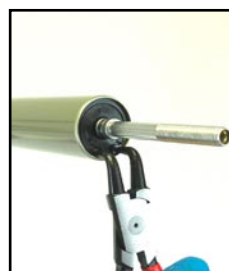
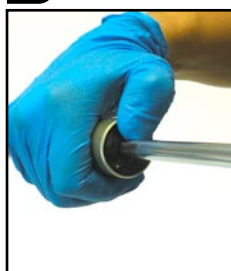

17. Use a 24 mm socket wrench to tighten the top cap to 7.3 N·m (65 in-lb).

16



17



AIR U-TURN SPRING SERVICE

(REBA)

INTRODUCTION

At this point you should already have the lower legs removed from your fork. If not, you will need to return to the Lower Leg Removal section of this manual and follow the instructions for removing your fork lower legs.

AIR U-TURN SPRING REMOVAL/SERVICE INSTRUCTIONS

CAUTION
Verify all pressure is removed from the fork before proceeding. Depress the Schrader valve again to remove any remaining air pressure. Failure to do so can result in injury and/or damage to the fork.

1. Apply downward pressure to the Air U-Turn adjuster knob and use a pick or flat bladed screwdriver to push/pull the knob retaining clip off of the air valve body. Remove the adjuster knob.
2. Use a magnet to remove the detent ball bearings and detent springs from the top cap.
3. Use a 24 mm socket wrench to loosen and unthread the top cap. Remove the top cap and the entire air assembly from the top of the fork. Once removed, clean the upper tube threads with a rag.
4. Unthread the top cap from the top of the air assembly. Use a pick to remove the plastic washer from inside of the top cap or from the top of the travel adjustment shaft. Set the washer aside.
5. Use a pick to remove the top cap o-ring. **When using a pick to remove o-rings, do not scratch the top cap. Scratches may cause air to leak.**
6. Use small external snap ring pliers to remove the small external snap ring located at the bottom of the air assembly, then remove the negative piston retention plate. **Compress the snap ring just enough to remove it from its groove. Over-extending the snap ring can permanently damage it and cause air spring assembly failure.**

1



2



3

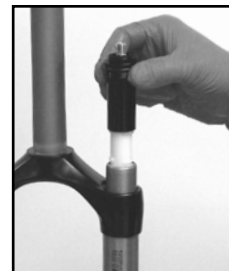

4

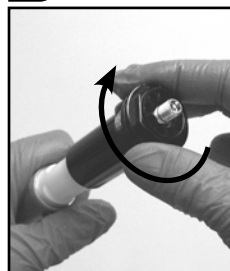

6

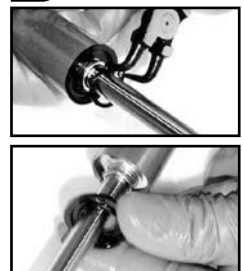

Do not scratch the air spring shaft surface while removing the snap ring. Scratches on the air spring shaft will allow air to bypass the seal head into the lower legs, resulting in reduced spring performance.

AIR U-TURN SPRING REMOVAL/SERVICE INSTRUCTIONS (CONTINUED)

7. Use large internal snap ring pliers to remove the snap ring from the bottom of the air tube. Use the tips of the pliers to press the aluminum negative piston slightly into the air tube while engaging the snap ring for a more secure snap ring engagement. Remove the snap ring by guiding it off of the air shaft by hand.
8. Pull the air shaft, negative piston and air piston assembly out of the air tube.
9. Spray isopropyl alcohol on the air shaft and wipe it with a clean rag.
10. Slide the aluminum negative piston and top out bumper from the air shaft. Use a pick to remove the inner and outer negative piston o-rings. Apply grease to the new o-rings and install them.
11. Re-install the top out bumper and negative piston onto the air shaft with the flat side of the negative piston oriented toward the air piston.
12. Use a pick to remove the air piston o-ring. Apply grease to the new o-ring and install it.
13. Place the bottom of the air tube against a sturdy, flat working surface. Use a plastic mallet to lightly tap the air valve body multiple times until you feel the choke assembly disengage from the air tube.
The choke assembly will feel tight while disengaging from the air tube. Avoid tapping firmly against the valve body as this may cause damage. Multiple light taps will disengage the choke assembly without damaging any parts.
14. Use a dowel to continue to push the choke assembly through and out of the air tube. Remove the choke assembly completely from air tube.
15. Spray isopropyl alcohol on the inside and outside of the air tube and wipe with a clean rag. Wrap a clean rag around a long dowel and insert it into the air tube to clean inside the air tube.

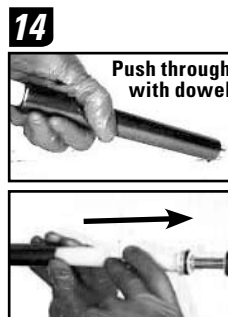
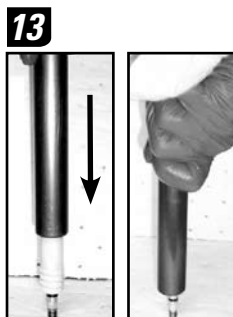
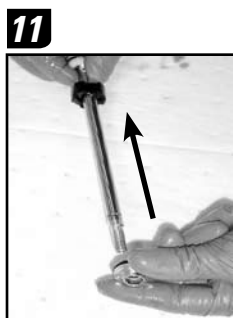
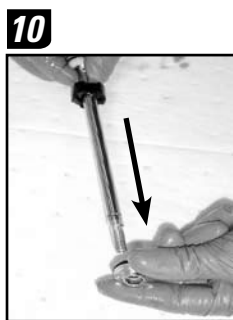
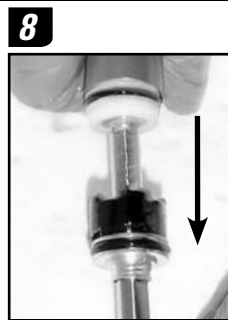

AIR U-TURN SPRING REMOVAL/SERVICE INSTRUCTIONS (CONTINUED)

16. Use small external snap ring pliers to remove the choke piston retaining ring from the travel adjustment shaft. Remove the choke piston and choke piston/shaft washer.
17. Remove the choke piston o-ring. Apply grease to the new o-ring and install.
18. Remove the travel adjustment seal head from the travel adjustment shaft.
19. Use a pick to remove both the inner and outer seal head o-rings. Apply grease to the new o-rings and install.
20. Use a pick to remove the travel adjustment shaft o-ring. Apply grease to the new o-ring and install it.
21. Apply grease to the travel adjustment seal head inner o-ring. Re-install the travel adjustment seal head onto the travel adjustment shaft.
Be sure the keys on the travel adjustment shaft are inserted into the narrower key slots in the travel adjustment seal head.
22. Install the choke piston/shaft washer and the choke piston onto the travel adjustment shaft. Use small external snap ring pliers to install a **new** snap ring onto the travel adjustment shaft.
23. Apply grease to both piston outer o-rings.
24. Apply a thin film of grease to the snap ring groove inside of the open end of the air spring tube. Insert the upper choke assembly into the open end of the air spring tube, air valve first, and press completely into the air tube.
25. Using a long non-metallic dowel, push the choke assembly up into the air tube until it is seated flush against the inside of the rolled end of the air tube. Firmly pull on the choke assembly to ensure a secure fit against the inside of the air tube.

You may need to guide the choke assembly through the opening at the rolled end of the air tube to prevent the choke assembly outer threads from getting caught on the air tube lip.

16



17



18



19

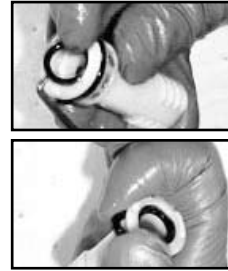

20



21



22



23

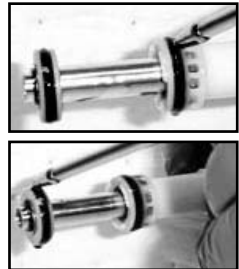

24



25

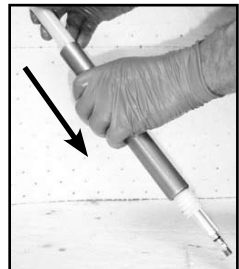

AIR U-TURN SPRING INSTALLATION INSTRUCTIONS

26. Apply grease to the air piston and negative piston outer o-rings. Insert the air piston into the open end of the air spring. Push the air shaft assembly into the air tube. Push the negative piston into the air tube until it is seated just past the snap ring groove.

26



27



27. Wipe any remaining grease from the snap ring groove with a clean rag. Use large internal snap ring pliers to secure the snap ring into its groove. **Make sure the snap ring is securely fastened in the snap ring groove. You can check this by using the snap ring pliers to rotate the snap ring back and forth a couple of times, then firmly pulling down on the air shaft.**

28



Snap rings have a sharper-edged side and a rounder-edged side. Installing snap rings with the sharper-edged side facing the tool will allow for easier installation and removal.

28. Insert the negative piston retention plate into the end of air tube, stepped side first. Use small external snap ring pliers to re-install the retention plate snap ring.

Compress the snap ring just enough to install it into its groove. Over-extending the snap ring can permanently damage it and cause air spring assembly failure.

29



30

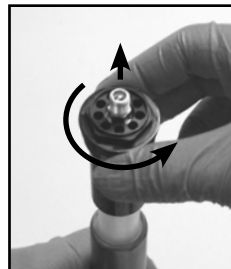

The Air U-Turn assembly is now assembled and ready to be installed into fork upper tube/crown.

29. Place the plastic washer over the air valve and seat it against the top of the keys on the travel adjustment shaft. Apply grease to the travel adjustment seal head threads and shaft o-ring. Insert the Air U-Turn assembly into bottom of the non-drive side upper tube, choke assembly end first.

30. Thread the top cap onto the travel adjustment seal head until the Schrader valve is completely extended from the hole in the center of the top cap.

AIR U-TURN SPRING INSTALLATION INSTRUCTIONS (CONTINUED)

31. Apply a few drops of blue thread lock to the top cap outer threads. Use a 24 mm socket wrench to thread the top cap into the upper tube. Tighten it to 14.6 N·m (130 in-lb).
32. Place the detent springs into the top cap detent holes, leaving one empty hole between each spring (this will result in two springs located in two consecutive holes, the location of which is not critical). Place a detent ball bearing on top of each detent spring.

Make sure you use all five springs and bearings, otherwise the knob can turn and change travel on its own.

33. Place the Air U-Turn adjuster knob on the hex-shaped shaft end. Press down on the adjuster knob to access the retaining ring groove below the valve body threads. While pressing down on the knob, use a flat bladed screwdriver to secure the knob retaining ring, from the side, onto the valve body.

Make sure retaining ring is inserted into the groove, not the air shaft threads.

The Air U-Turn fork must be set the to full travel setting before installing the lower legs. Turn the Air U-Turn adjuster knob counter-clockwise to set the fork to full travel.

31



32



33

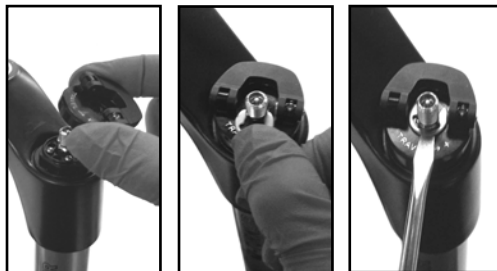

TURNKEY DAMPER SERVICE

(REBA TK - RECON GOLD TK - SEKTOR TK)

INTRODUCTION

At this point you should already have the lower legs removed from your fork. If not, you will need to return to the Lower Leg Removal section of this manual and follow the instructions for removing your fork lower legs.

DAMPER SERVICE INSTRUCTIONS

- 1. Crown Mount (non-remote) Only:** Use a 2.5 mm hex key to remove the adjuster knob retention screw. Remove the adjuster knob.

OR

Remote Only: Use a 2 mm hex wrench to loosen the cable pinch bolt and remove the cable. Use a 2 mm hex wrench to loosen the cable stop collar clamping bolt. Remove the cable stop collar.

You do not need to remove the remote cable spool.

2. Unthread the compression damper top cap with a 24 mm socket and socket wrench. Once removed, clean the upper tube threads with a rag.
3. Remove the compression damper by pulling up and gently rocking it from side to side. Once removed, clean the upper tube threads with a rag.
4. Remove the compression damper top cap o-ring and piston o-ring. Apply a few drops of RockShox suspension oil to the new o-rings and install them.
5. Remove the fork from the bicycle stand and pour the oil into an oil pan.
6. Clamp the fork back into the bicycle stand. Push the rebound shaft into the seal head, leaving just enough shaft exposed to hold onto with your fingers. Use large internal snap ring pliers to remove the rebound damper seal head retaining ring (located inside the bottom of the drive side upper tube). Pull down and remove the rebound damper and seal head assembly from the upper tube.

1



Crown Mount OR



Remote



Remote

2



3

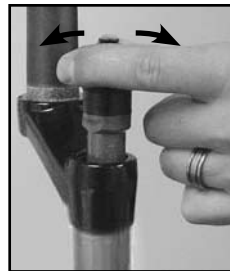

4



5



6

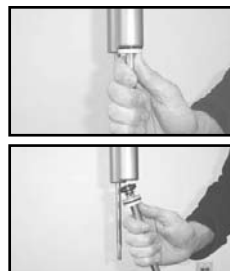

OPTIONAL - COMPRESSION DAMPER UPGRADE: NON-REMOTE TO REMOTE ADJUST

Upgrading from a non-remote compression adjust fork to a remote compression adjust (from a crown mounted adjuster knob to a remote PopLoc or PushLoc lever adjuster), requires replacing the non-remote compression damper with a remote compression damper and cable-stop clamp. The remote return spring is integrated into the compression damper and is required for use with the PopLoc and PushLoc remote lever assembly.

DAMPER SERVICE INSTRUCTIONS (CONTINUED)

7. **Reba, Recon Gold, and Sektor Solo Air only:** Slide the seal head off the damper shaft and use a pick to remove the inner and outer seal head o-rings. Apply a few drops of RockShox suspension oil to new o-rings and install them. **If using a pick to remove o-rings, do not scratch the o-ring glands. Scratches may cause oil to leak.**

OR

Sektor Coil and U-Turn only: Slide the seal head, negative spring, and travel spacer(s) (if applicable) off the damper shaft and use a pick to remove the inner and outer seal head o-rings. Apply a few drops of RockShox suspension oil to new o-rings and install them. **If using a pick to remove o-rings, do not scratch the o-ring glands. Scratches may cause oil to leak.**

8. Spray isopropyl alcohol on the rebound damper shaft and wipe it with a clean rag.
9. Replace the rebound damper piston glide ring. Position the upper tube base ring on top of the seal head step (**Recon Gold only**) and slide the rebound seal head assembly onto the rebound damper shaft.
10. Spray isopropyl alcohol into the upper tube. Wrap a clean rag around a dowel and clean the inside of the upper tube.
11. Insert the rebound damper piston into the bottom of the upper tube at an angle, with the side of the glide ring opposite the split entering the upper tube first. Continue to angle and rotate until the glide ring is in the upper tube.
12. Position the upper tube base ring and rebound seal head into the upper tube. Push the seal head firmly into the bottom of the upper tube until the retaining ring groove is visible.

7

Reba, Recon Gold,
Sektor Solo Air



Sektor Coil,
U-Turn



9



11



12

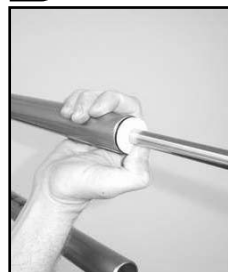

DAMPER SERVICE INSTRUCTIONS (CONTINUED)

13. Push the rebound damper shaft into the seal head, leaving just enough to grab onto. Use large internal snap ring pliers to secure the snap ring into the snap ring groove.

Make sure the snap ring is securely fastened in the snap ring groove. You can check this by using the snap ring pliers to rotate the snap ring back and forth a couple of times, then firmly pulling down on the damper shaft.

13



Snap rings have a sharper-edged side and a rounder-edged side. Installing snap rings with the sharper-edged side facing towards the tool will allow for easier installation and removal.

14. Orient the fork upright in the bicycle stand. Pull the rebound damper shaft down to the fully extended position. Measure and slowly pour 5wt RockShox suspension oil into the upper tube using the volumes listed in the chart below.

Oil volume is critical. Too much oil reduces available travel, too little oil decreases damping performance.

14



Fork	Oil Volume (±3 mL)
Reba TK	133 mL
Recon Gold TK	133 mL
Sektor TK Coil 130	120 mL
Sektor TK Coil 140/150	125 mL
Sektor TK U-Turn	125 mL
Sektor TK Solo Air	130 mL

15

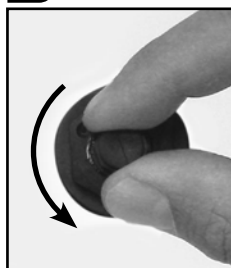

15. **Crown Mount (non-remote) only:** Turn the hex-shaped compression adjuster fully counter-clockwise.

16. Insert the compression damper into the upper tube through the crown. Press down on and rock the damper from side to side to work it into the upper tube, being careful not to damage the o-ring on the upper tube threads. Hand tighten the damper into the upper tube.

16

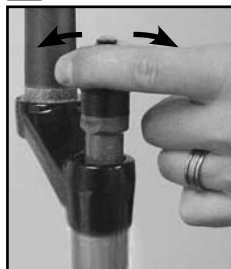

17. Use a 24 mm socket wrench to tighten the compression damper to 7.3 N·m (65 in·lb).

17



DAMPER SERVICE INSTRUCTIONS (CONTINUED)

- 18. Crown Mount (non-remote) only:** Place the compression adjuster knob onto the top cap with the knob dial set in the 2 o'clock position. Use a 2.5 mm hex key to install the adjuster knob retention screw and tighten it to 1.3 N·m (11 in-lb).

OR

Remote Only: Install the cable stop collar onto the top cap with the cable stop facing toward the front of the fork, perpendicular to the crown. Use a 2 mm hex to tighten the cable stop clamping bolt to 1.4 N·m (12 in-lb).

Move on to the *Remote Service* section for instructions on how to install the remote lever and cable assembly.

18



Crown-Mount

OR

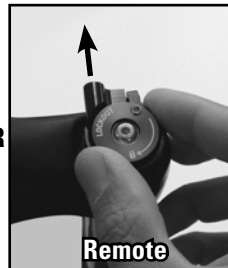

Remote

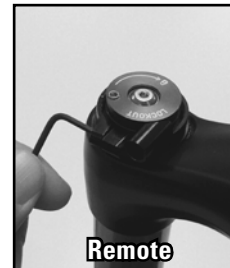

Remote

MOTION CONTROL/BLACKBOX MOTION CONTROL DAMPER SERVICE

(ARGYLE RCT - REBA RL, RLT, RLT Ti - RECON GOLD RL - REVELATION RL, RLT, RLT Ti, WC - SEKTOR RL - SID RL, RLT, RLT Ti, WC)

INTRODUCTION

At this point you should already have the lower legs removed from your fork. If not, you will need to return to the Lower Leg Removal section of this manual and follow the instructions for removing your fork lower legs.

DAMPER REMOVAL/SERVICE INSTRUCTIONS

1. Compression adjuster removal

Crown mounted (non-remote) compression adjusters:

1a. Argyle only: You do not need to remove the compression knob. Move on to step 2.

1b. Reba RLT/RLT Ti, Revelation RLT/RLT Ti/WC, SID RLT/RLT Ti/WC only: Use a 1.5 mm hex wrench to loosen the Floodgate knob set screw. Remove the Floodgate knob, compression adjuster knob, and o-ring/washer seal.

1c. Reba RL, Revelation RL, SID RL only: Use small external snap ring pliers to remove the external snap ring from the compression adjuster knob. Remove the compression adjuster knob and o-ring/washer seal.

1d. Recon Gold, Sektor only: Use a 2.5 mm hex wrench to remove the adjuster knob retention screw. Remove the adjuster knob and detent leaf spring.

1b



1c



1d



DAMPER REMOVAL/SERVICE INSTRUCTIONS (CONTINUED)

Remote mounted compression adjusters:

1e. Reba RLT/RLT Ti, Revelation RLT/RLT Ti/WC, SID RLT/RLT Ti/WC only: Use a 1.5 mm hex wrench to loosen the Floodgate knob set screw. Remove the Floodgate knob and the remote spool. Use a 2 mm hex wrench to loosen the cable stop collar bolt. Remove the cable stop collar. Remove the o-ring/washer seal.



1f. Reba RL, Recon Gold, Revelation RL, Sektor, SID RL only: Use a 2 mm hex wrench to loosen the cable stop collar bolt. Remove the cable stop collar. You do not need to remove the remote spool.



2. Use a 24 mm socket wrench to unthread the compression damper top cap.
3. Remove the compression damper from the upper tube/crown by pulling up and rocking it from side to side.
4. Remove the compression damper top cap o-ring and piston o-ring. Apply grease to the new o-rings and install them.

If using a pick to remove o-rings, do not scratch the o-ring gland. Scratches may cause oil to leak.

5. Remove the fork from the bicycle stand and pour any remaining oil into an oil pan.
6. Push the rebound shaft into the seal head, leaving just enough shaft exposed to hold onto with your fingers. Use large internal snap ring pliers to remove the rebound damper seal head retaining ring, located inside the bottom of the drive side upper tube.
7. Pull down and remove the rebound damper and seal head assembly from the upper tube.
8. Slide the seal head off the damper shaft. Use a pick to remove the inner and outer seal head o-rings. Apply grease to the new o-rings and install them.
9. Remove and replace the rebound damper piston glide ring.
10. Spray isopropyl alcohol on the rebound damper shaft and wipe it with a clean rag.

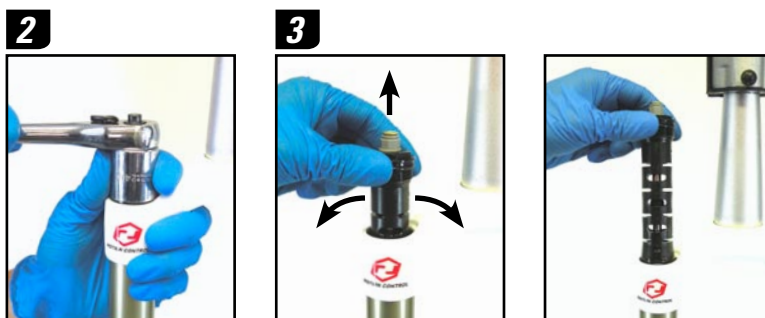

DAMPER INSTALLATION INSTRUCTIONS

11. Slide the rebound seal head assembly onto the rebound damper shaft.
12. Spray isopropyl alcohol into the upper tube. Wrap a clean rag around a dowel and clean the inside of the upper tube.
13. Insert the rebound damper piston into the bottom of the upper tube at an angle, with the side of the glide ring opposite the split entering the upper tube first. Continue to angle and rotate until the glide ring is in the upper tube.
14. Push the seal head firmly into the bottom of the upper tube until the retaining ring groove is visible.

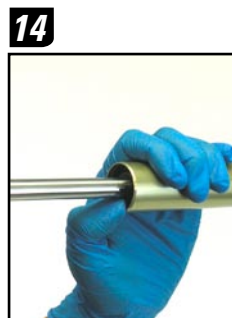
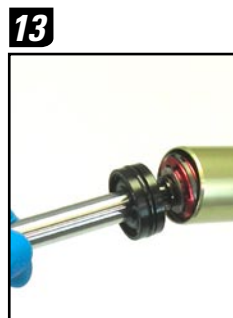

15. Push the rebound damper shaft into the seal head, leaving just enough to grab onto. Use large internal snap ring pliers to secure the snap ring into the snap ring groove.

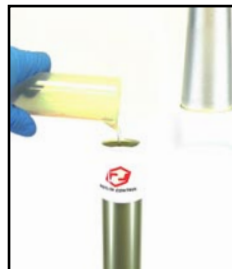

Make sure the snap ring is securely fastened in the snap ring groove. You can check this by using the snap ring pliers to rotate the snap ring back and forth a couple of times, then firmly pulling down on the damper shaft.

Snap rings have a sharper-edged side and a rounder-edged side. Installing snap rings with the sharper-edged side facing towards the tool will allow for easier installation and removal.

16. Orient the fork upright in the bicycle stand. Pull the rebound damper shaft down to the fully extended position. Measure and slowly pour 5wt RockShox suspension oil into the upper tube, using the following volumes:

Fork	Oil Volume (±3 mL)
Argyle RCT	120 mL
Reba RL, RLT	123 mL
Reba RLT Ti	133 mL
Recon Gold RL	133 mL
Revelation RL, RLT	123 mL
Revelation RLT Ti, WC	133 mL
Sektor RL (Solo Air 130 -150 mm)	130 mL
Sektor RL (Coil U-Turn 150 mm)	125 mL
Sektor RL (Coil U-Turn 140 mm)	125 mL
Sektor RL (Coil U-Turn 130 mm)	120 mL
SID RLT (100 mm)	94 mL
SID RLT Ti, WC (100 mm)	96 mL
SID RLT, RLT Ti, WC (120 mm)	106 mL

Oil volume is critical. Too much oil reduces available travel, too little oil decreases damping performance.

DAMPER INSTALLATION INSTRUCTIONS (CONTINUED)

17. Turn the hex-shaped compression adjuster counter-clockwise until it stops, so the damper is in the full open position. Insert the compression damper into the upper tube. Press down and rock the damper from side to side to work it into the upper tube.

17



18



18. Use a 24 mm socket wrench to thread the compression damper into the upper tube and tighten it to 7.3 N·m (65 in-lb).

Argyle only: This completes damper service and installation.

19. Compression adjuster installation

Crown mounted (non-remote) compression adjusters:

19a. Reba RLT/RLT Ti, Revelation RLT/RLT Ti/WC, SID RLT/RLT Ti/WC only: Install the o-ring/washer seal followed by the compression adjuster knob onto the top cap, with the knob dial set in the 2 o'clock position. Install the floodgate knob onto the compression knob. Use a 1.5 mm hex wrench to tighten the Floodgate knob set screw to 0.6 N·m (6 in-lb).

19a



19b. Reba RL, Revelation RL, SID RL only: Install the o-ring/washer seal followed by the compression adjuster knob onto the top cap, with the knob dial set in the 2 o'clock position. Use small external snap ring pliers to install the external snap ring onto the compression adjuster knob.

19b



19c. Recon Gold, Sektor only: Install the detent leaf spring onto the top cap so that the ends of the detent spring are located at the 3 o'clock and 9 o'clock positions. Install the compression adjuster knob onto the top cap and detent spring, with the knob dial set at the 2 o'clock position. Install the adjuster knob retention screw and use a 2.5 mm hex key to tighten it to 1.3 N·m (11 in-lb).

19c



DAMPER INSTALLATION INSTRUCTIONS (CONTINUED)

Remote mounted compression adjusters:

19d. Reba RLT/RLT Ti, Revelation RLT/RLT Ti, SID RLT/RLT Ti only: Install the o-ring/washer seal onto the top cap. Install the cable stop collar onto the top cap with the cable stop facing toward the front of the fork, perpendicular to the crown. Use a 2 mm hex to tighten the cable stop collar bolt to 1.4 N·m (12 in-lb). Install the remote spool onto the top cap, with the cable set screw set in the 6 o'clock position. Install the Floodgate knob onto the remote spool. Use a 1.5 mm hex wrench to tighten the Floodgate knob set screw to 0.6 N·m (6 in-lb).

19e. Reba RL, Recon Gold, Revelation RL, Sektor, SID RL only: Install the cable stop collar onto the top cap with the cable stop facing toward the front of the fork, perpendicular to the crown. Use a 2 mm hex to tighten the cable stop collar bolt to 1.4 N·m (12 in-lb).

For forks equipped with a remote compression lockout feature, move on to the Remote Service section for instructions on how to install the remote lever and cable assembly.

19d



19e

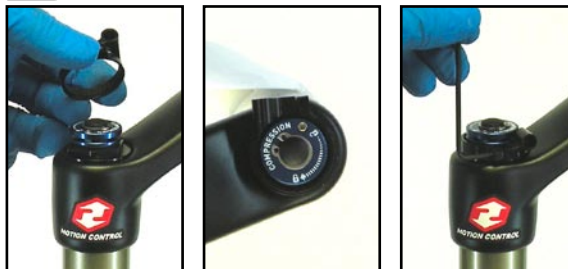

OPTIONAL - COMPRESSION DAMPER UPGRADE: NON-REMOTE TO REMOTE ADJUST

Upgrading from a non-remote compression adjust fork to a remote compression adjust - from a crown mounted adjuster knob to a remote PopLoc or PushLoc lever adjuster - requires replacing the non-remote compression damper with a remote compression damper and cable-stop clamp. The remote return spring is designed into the compression damper and is required for use with the PopLoc and PushLoc remote lever assembly.

LOWER LEG INSTALLATION

INTRODUCTION

At this point you should already have already serviced your fork seals, damper system, and spring system. Once you have re-installed your fork lower legs, you will have successfully serviced your fork and you will be ready to ride!

LOWER LEG INSTALLATION INSTRUCTIONS

1. Spray the upper tubes with isopropyl alcohol and wipe them with a clean rag.
2. Apply a small amount of grease to the inner surfaces of the dust wipers, oil seals, and foam rings (if applicable).

For hollow bottom fork legs, skip to step 6.

3. **Non-hollow bottom fork legs:** Slide the lower leg assembly onto the upper tube assembly just enough to engage the upper bushing with the upper tubes.

Make sure both dust seals slide onto the tubes without folding the outer lip of either seal.

4. Reference the oil chart at the beginning of this manual for proper oil weight and volumes for lower leg lubrication. Invert the fork so that the bottom of the fork is angled upward at about 45°. Measure and inject/pour suspension oil into each lower leg through the shaft bolt hole.
5. Slide the lower leg assembly along the upper tubes until it stops and the spring and damper shafts are visible through the shaft bolt holes (**Dual Air, Air U-Turn, and Dual Position Air** spring shafts should extend through the shaft bolt hole). Wipe all excess oil from the outer surface of the lower legs. Skip to step 8.

2



3

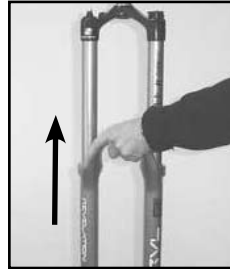

4



5

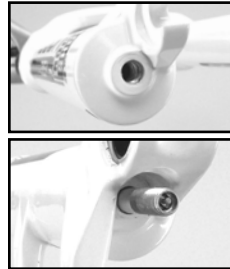

LOWER LEG INSTALLATION INSTRUCTIONS (CONTINUED)

Hollow bottom fork legs:

6. Reference the oil chart at the beginning of this manual for proper oil weight and volumes for lower leg lubrication. Hold the lower leg assembly horizontally and inject/pour suspension oil into each leg from the dust seal side.
7. Position the upper tube assembly horizontally then slide the lower leg assembly onto the upper tube assembly until it stops and the spring and damper shafts are visible through the shaft bolt holes (**Dual Air, Air U-Turn, and Dual Position Air** spring shafts should extend through the shaft bolt hole). Wipe all excess oil from the outer surface of the lower legs.
Be careful not to spill any oil from the lower leg as you install it onto the upper tubes.

Make sure both dust seals slide onto the upper tubes without folding the outer lip of either seal.

8. Inspect and clean the damper and air spring shaft bolts/nut, nylon crush washers and crush wash retainers. Replace crush washers and crush washer retainers if damaged.
You must clean dirty crush washers and replace flattened or deformed crush washers and/or crush washer retainers. Dirty or damaged crush washers can cause oil to leak from the fork.
9. Insert the shaft bolts into the threaded shaft ends through the lower leg shaft holes (or air shaft nut onto the threaded shaft end), and tighten with a 5 mm hex (bolt) or 10 mm socket wrench (nut) to 7.3 N-m (65 in-lb).
For hollow bottom fork legs you will need to use a socket extension for the 5 mm bolt and a deep 10 mm socket to thread the Dual Air shaft nut.
10. **For forks with an external rebound adjuster,** insert the external rebound damper knob into the rebound damper shaft bolt. Push it in until secure. Adjust as desired.
11. **For air sprung forks,** refer to the air chart on your fork and inflate the positive and negative (if applicable) air chamber(s) to the appropriate pressure.
12. Spray isopropyl alcohol on entire fork and wipe it with a clean rag.
13. **For air sprung forks,** thread the positive and negative (if applicable) air valve cap(s) onto the air valve(s).

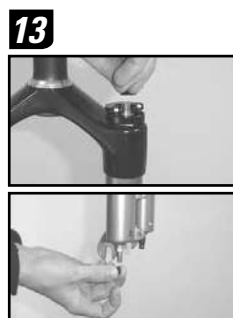
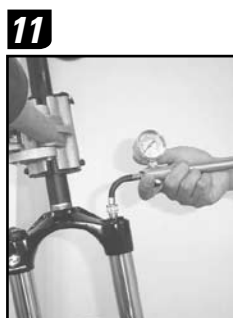
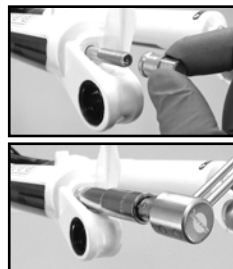
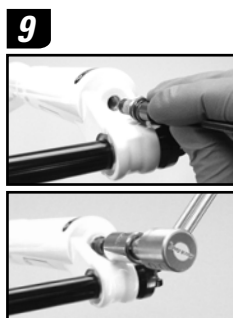
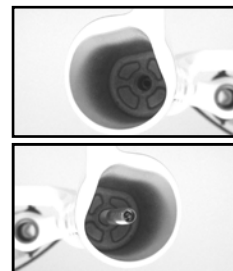
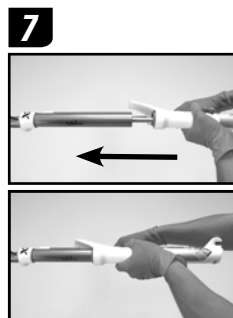

REMOTE SERVICE

(PUSHLOC - POPLOC ADJUST - POPLOC)

INTRODUCTION

Damper service for forks equipped with remote lockouts will require cable and housing removal and installation. Also, periodic replacement of the cable and housing is recommended for optimal remote performance.

CABLE REMOVAL INSTRUCTIONS

FORK LOCKOUT ANATOMY

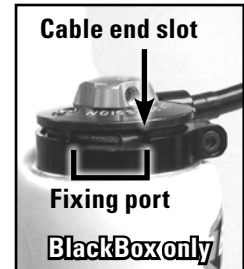
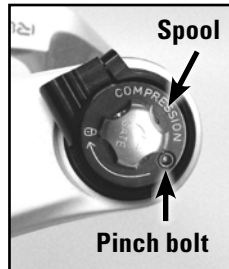

- 1. PushLoc only:** Push the remote lever until it returns toward you.
PopLoc and PopLoc Adjust only: Press the button next to the remote lever to set the lever to the fully released, or "Unlocked" position.
- BlackBox Motion Control, Lyrik RLR, and Lyrik RLR+ only:** Use a 2 mm hex wrench to loosen the cable pinch bolt on the spool and pull the cable out of the cable end slot. Use pliers to remove the cable end.



OR

- Motion Control only:** Use a 2 mm hex wrench to loosen the cable pinch bolt on the spool. Use pliers to remove the cable end.
- 3. PushLoc only:** Push the remote lever to the "Locked Out" position. Use your finger to open the cable hatch cover (labeled *CC*, for *Cable Change*). Push the cable through the spool on the fork until the cable head is far enough out of the lever to access.
PopLoc and PopLoc Adjust only: Push the cable through the spool until the cable head is far enough out of the lever to grab onto.
- 4.** Pull the cable head to remove the cable completely from the remote system.
- 5.** If replacing the cable housing, detach the cable housing and end caps from the lever and the cable housing stop on the fork.

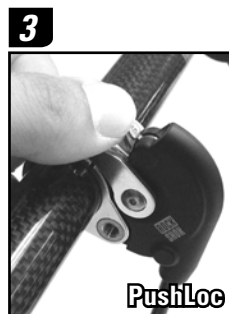
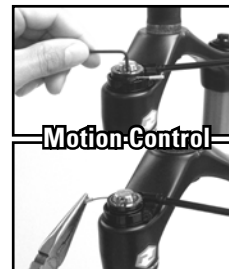
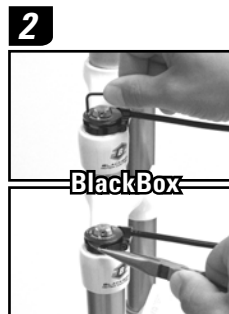

CABLE INSTALLATION INSTRUCTIONS

6. If replacing the cable housing, attach the new housing and end caps to the remote lever and the cable housing stop on the fork. Be sure to use compressionless (shift) housing cut to an adequate length to accommodate for travel change and suspension movement.

7. **PopLoc and PopLoc Adjust only:** Push the release button to verify the remote is in the "Unlocked" position.

PopLoc Adjust only: Turn the blue compression adjustment dial counter-clockwise until it stops.

8. Insert the tip of a new shifter cable into the port on the lever and feed the cable through the housing and the cable housing stop on the fork.

9. Pull the cable until the cable head is seated completely in the remote lever.

PushLoc only: Once the cable head is seated in the remote lever body, close the cable hatch cover and push the lever to return it to the "Unlocked" position.

10. **BlackBox Motion Control, Lyrik RLR, and Lyrik RLR+ only:** Wrap the cable around the spool and insert it through the cable fixing port. While pulling the cable firmly, use a 2 mm hex wrench to tighten the cable pinch bolt to 0.9 N·m (8 in-lb). Cut the excess cable, leaving 30 mm protruding from the cable fixing port. Cap the end of the cable with a non-flanged, or "road style" cable end. Tuck the cable end into the cable end slot in the spool.

OR

Motion Control only: Wrap the cable around the spool. While pulling the cable firmly, use a 2 mm hex wrench to tighten the cable pinch bolt to 0.9 N·m (8 in-lb). Cut the excess cable and cap it with a cable end.

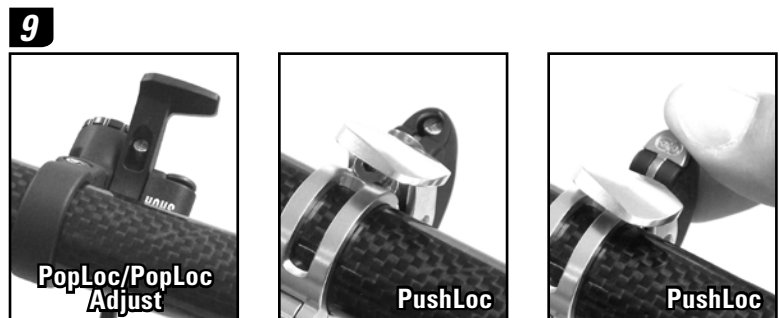
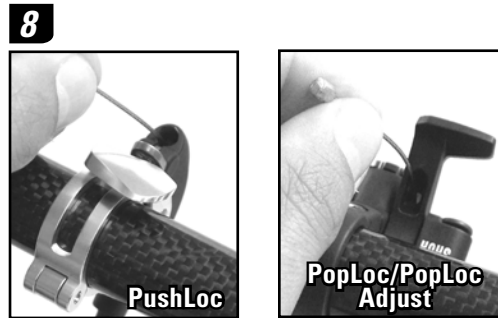
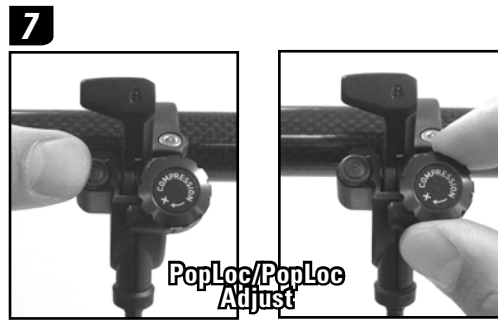

www.sram.com

WORLD HEADQUARTERS

SRAM, LLC
1333 N. Kingsbury St., 4th Fl
Chicago, Il 60642
Phone +1-312-664-8800
Fax +1-312-664-8826

EUROPEAN HEADQUARTERS

SRAM Europe
Paasbosweg 14-16
3862ZS Nijkerk
The Netherlands
Phone +31-33-450-6060
Fax +31-33-457-0200

ASIAN HEADQUARTERS

SRAM Taiwan
No. 1598-8 Chung Shan Rd
Shen Kang Hsiang, Taichung
County 429 Taiwan R.O.C.
Phone +886-4-2564-3678
FAX +886-4-2561-3686